

MIFARE CONTACTLESS, ISO7816 CONTACT IC CARD READ/WIRTE READER MODULE

JMY680M IC Card Reader

User's manual

(Revision 3.50)

Jinmuyu Electronics Co. LTD

2012/6/28



Please read this manual carefully before using. If any problem, please mail to: Jinmuyu@vip.sina.com



Contents

1	Product introduction.....	3
2	Characteristics.....	3
3	Physical parameter and pin outs.....	4
3.1	Photo.....	4
3.2	Dimension.....	4
3.3	Pin configurations and pin outs.....	5
3.4	Model available.....	5
3.5	Model naming rule.....	5
3.5.1	Model format.....	5
3.5.2	Card operating type.....	5
3.5.3	Communication port.....	6
4	Communication Protocols.....	7
4.1	Overview.....	7
4.2	UART protocol.....	7
4.2.1	Parameters.....	7
4.2.2	Data send format.....	7
4.2.3	Data return format.....	7
4.3	IIC protocol.....	8
4.3.1	Module IIC address and multi device communications.....	8
4.3.2	IIC device operation.....	8
4.3.2.1	Clock and data transaction.....	8
4.3.2.2	Start condition.....	8
4.3.2.3	Stop condition.....	8
4.3.2.4	Acknowledge (ACK).....	9
4.3.2.5	Bus state.....	9
4.3.2.6	Device addressing.....	9
4.3.2.7	Write data operation.....	9
4.3.2.8	Read data operation.....	9
4.3.3	Data transaction.....	10
4.3.4	Data send format.....	10
4.3.5	Data return format.....	10
4.3.6	Description of IIC command transaction.....	10
5	Description of commands.....	12
5.1	List of commands.....	12
5.2	Explanation of commands.....	13
5.2.1	Read product information.....	13
5.2.2	Module working mode set.....	13
5.2.3	Set module idle.....	14
5.2.4	Set LED.....	14
5.2.5	Set buzzer.....	15
5.2.6	EEPROM read.....	15
5.2.7	EEPROM write.....	16



5.2.8	Set UART communication baud rate.....	16
5.2.9	Set IIC communication address.....	16
5.2.10	Set multi-card operation.....	17
5.2.11	Set automatic detecting card interval time.....	17
5.2.12	Set the default automatic detect card state default.....	18
5.2.13	Set automatic detect card and output card UID default.....	18
5.2.14	ISO14443A request cards.....	19
5.2.15	Mifare 1K/4K data block read.....	19
5.2.16	Mifare 1K/4K multi blocks read.....	20
5.2.17	Mifare 1K/4K data block write.....	20
5.2.18	Mifare 1K/4K multi blocks write.....	21
5.2.19	Mifare 1K/4K purse block initialize.....	21
5.2.20	Mifare 1K/4K purse read.....	22
5.2.21	Mifare 1K/4K purse increment.....	22
5.2.22	Mifare 1K/4K purse decrement.....	23
5.2.23	Mifare 1K/4K purse copy.....	23
5.2.24	ISO14443A card halt.....	24
5.2.25	Download Mifare 1K/4K card key to module.....	24
5.2.26	Ultra Light card read.....	24
5.2.27	Ultra Light card write.....	25
5.2.28	SAM slot default baud rate set.....	25
5.2.29	SAM reset.....	26
5.2.30	Set SAM baud rate after reset (through PPSS).....	26
5.2.31	Send APDU to SAM.....	26
5.3	About KEY Identification.....	28
5.4	About the automatic detecting card.....	28
5.5	Example of commands.....	29
5.5.1	About UART communication protocol.....	29
5.5.2	UART commands sample.....	29
5.5.3	IIC commands sample.....	29
5.6	Interface program source code.....	29



1 Product introduction

JMY680M is a RFID read/write module with UART, IIC, RS232C or USB port. JMY680M has various functions and supports multi ISO/IEC standard of contactless card. The RF protocol is complex, but the designer combined some frequent used command of RF card and then user could operate the cards with full function by sending simple command to the module. The modules build in SAM slot. It could operate contact smart card according to ISO7816.

The module and antenna is integrated. The impedance between RF circuit and antenna was tuned by impedance analyzer, and then the module has excellent performance and stability. There is ferrite plate between main PCB and antenna, so such design applies to some metallic-around systems.

2 Characteristics

- PCD model: NXP MF RC500
- Working frequency: 13.56MHz
- Supported standard: Mifare class, ISO7816
- Card supported: Mifare 1K/4K, FM11RF08, Ultra Light and ISO7816 SAM cards (both T=0 & T=1)
- Anti collision ability: Full function anti collision; be able to process multi-cards; be able to set operate single card only
- Auto detecting card: Supported, default OFF. The default state can be set
- SAM slot: 1 slot
- SAM baud rate: 9600bps/38400bps
- ISO7816 PPSS set: supported
- EEPROM: 512 Bytes
- Power supply: DC 5V ($\pm 0.5V$)
- Interface: IIC/UART/RS232C/USB (select while place order)
- Communication rate: IIC: 400Kbps
UART/RS232C/USB: 19.2Kbps/115.2Kbps
- Max. command length: 254 Bytes
- Interface level: UART/IIC: 3.3V (TTL level; 5V tolerance)
- Static power consumption: 150mA
- Operating distance: 80mm (depending on card)
- Dimension: 70mm*50mm*16.5mm
- Weight: About 120g
- ISP: Supported
- Operating temperature: -25 to +85 °C
- Storage temperature: -40 to +125 °C
- RoHS: Compliant



3 Physical parameter and pin outs

3.1 Photo

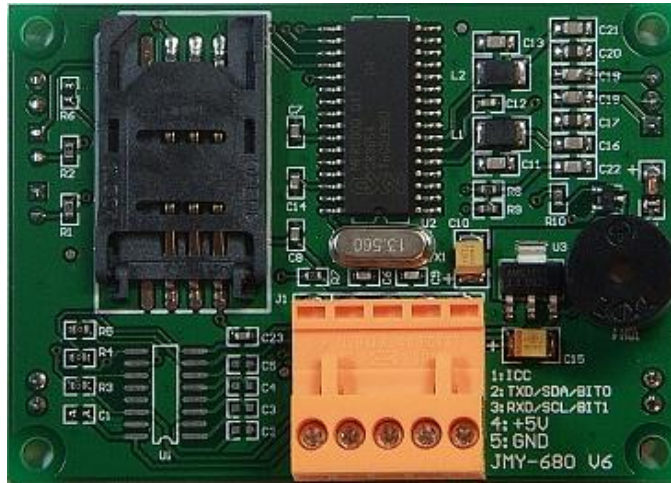

3.2 Dimension

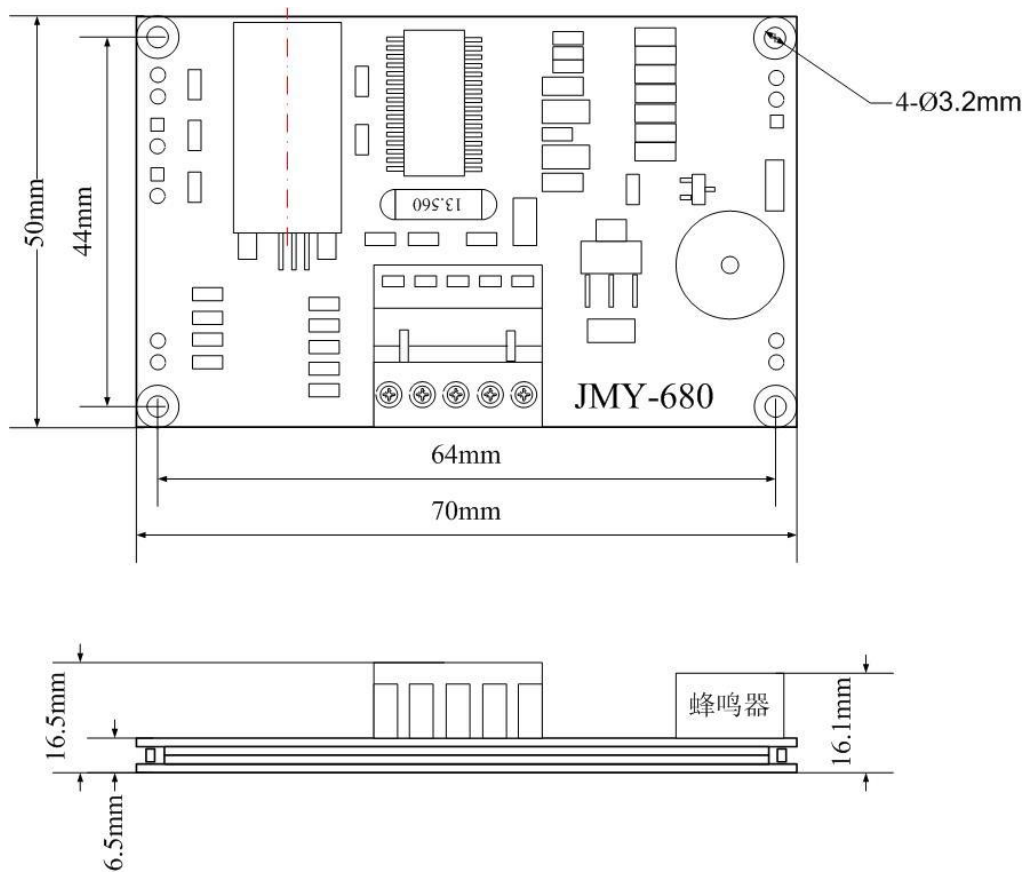



3.3 Pin configurations and pin outs

Pin number	Function	Type	Description
1	ICC	Output	Card in/out indication 0: Card IN; 1: Card OUT
2	TXD/SDA	Input/output	RS232C TXD / UART TXD / IIC SDA
3	RXD/SCL	Input	RS232C RXD / UART RXD / IIC SCL
4	VCC	Power	VCC
5	GND	Power	GND

3.4 Model available

- JMY680MI IIC interface
- JMY680MT UART interface, TTL level
- JMY680MS RS232C (UART interface, RS232 level)
- JMY680MU USB to UART Bridge (Mini USB port with 5 pins)

3.5 Model naming rule

3.5.1 Model format

1	2	3	4
JMY	680	X	X

1: company code; 2: product series code; 3: card operating type; 4: communication port type

3.5.2 Card operating type

M: PCD is RC500, support Mifare Class

A: PCD is RC500, support ISO14443A and Mifare Class

C: PCD is RC531, support ISO14443A, ISO14443B and Mifare Class

G: PCD is RC400, support ISO15693

H: PCD is RC632, support ISO15693, ISO14443A, ISO14443B and Mifare Class

D: PCD is RC500, support ISO14443A and Mifare Class with 511 bytes communication buffer

E: PCD is RC531, support ISO14443A/B and Mifare Class with 511 bytes communication buffer

F: PCD is RC632, support ISO15693, ISO14443A, ISO14443B and Mifare Class with 511 bytes communication buffer



3.5.3 Communication port

I: IIC

T: UART

S: RS232C

U: USB



4 Communication Protocols

4.1 Overview

There are optional IIC, UART or RS232C 3 types' hardware interface between the module and host. The communication rate of IIC is high. Moreover, IIC mode is very convenient, user may not modify the sample code except pin definition for actually use. The advantage of RS232C is the long communication distance, but UART don't need the modulate chip in the control terminal compare with RS232C.

Whatever types of interface user chooses. Please read this chapter before programming and refer to the sample program. There are detailed comments in the sample source code.

4.2 UART protocol

4.2.1 Parameters

The communication protocol is byte oriented. Both sending and receiving bytes are in hexadecimal format. The communication parameters are as follows:

- Baud rate: 19200bps(default), 115200bps
- Data bits: 8 bits
- Stop bits: 1 bit
- Parity check: None
- Flow control: None

4.2.2 Data send format

Length	Command	Data	Checksum
--------	---------	------	----------

- Length: 1 byte, number of bytes from Command length byte to the last byte of Data
- Command: 1 byte, the command of this instruction
- Data: length depends on the command type, length from 0 to 251 bytes
- Checksum: 1 byte, Exclusive OR (XOR) results from length byte to the last byte of data

4.2.3 Data return format

- Success:

Length	Command	Data	Checksum
--------	---------	------	----------

- Failure:

Length	Invert Command	Checksum
--------	----------------	----------



4.3 IIC protocol

4.3.1 Module IIC address and multi device communications

IIC bus is able to connect with 128 devices. The IIC address of module is default 0xA0. Users change the address setting via sending the command (0x19), so that user could connect multi modules on the same IIC bus.

4.3.2 IIC device operation

4.3.2.1 Clock and data transaction

The SDA pin is normally pulled high with an external device. Data on the SDA pin may change only during SCL low time periods. Data changes during SCL high periods will indicate a start or stop condition as defined below.

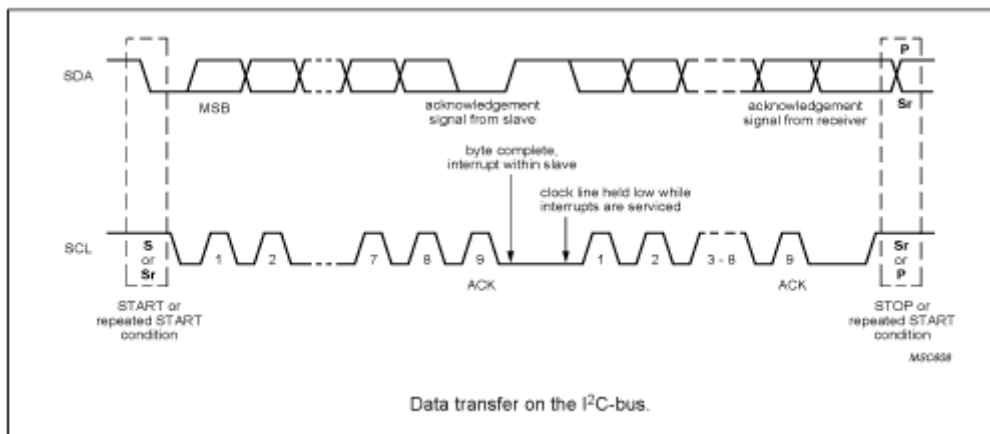

4.3.2.2 Start condition

A high-to-low transition of SDA with SCL high is a start condition, which must precede any other command.

4.3.2.3 Stop condition

A low-to-high transition of SDA with SCL high is a stop condition.

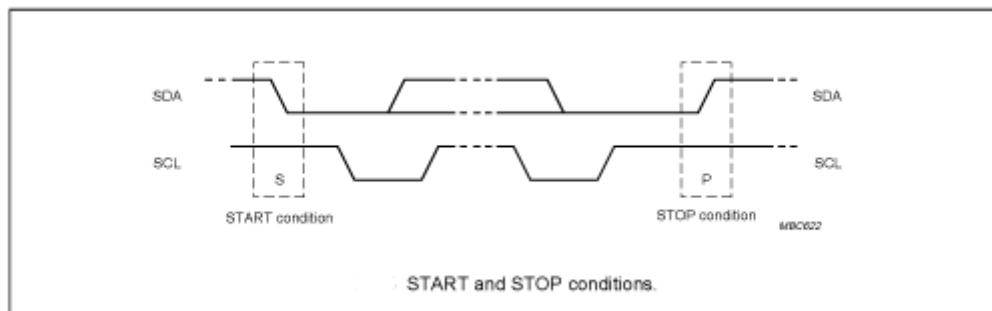



4.3.2.4 Acknowledge (ACK)

All addresses and data words are serially transmitted to and from the module in 8-bit words. The module sends a zero to acknowledge that it is not busy and has received each word. This happens during the ninth clock cycle.

4.3.2.5 Bus state

When the module has received command, and then doesn't acknowledge IIC bus until ends with the card communication.

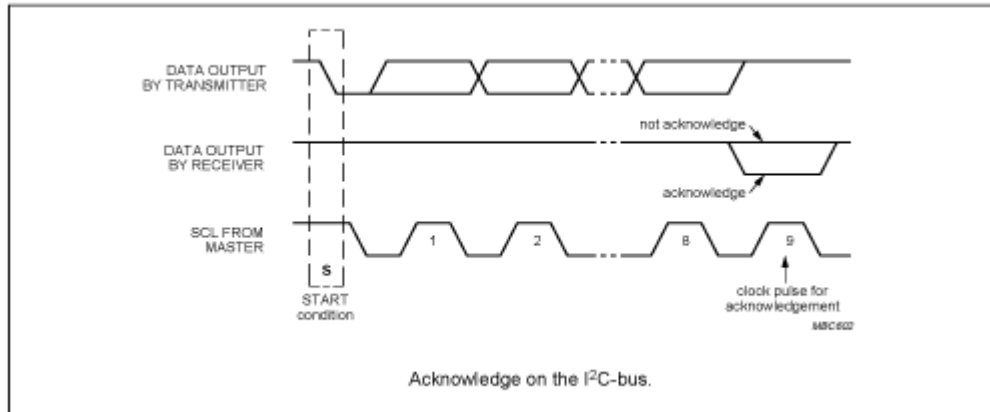

4.3.2.6 Device addressing

The module requires a 8-bit device address following a start condition to enable the chip for a read or write operation.

The device address word consists of 7 addressing bits and 1 operation select bit.

The first 7 bits of the module address are 1010000 (0xA0 in hex)

The eighth bit of the device address is the read/write operation select bit. A read operation is initiated if this bit is high and a write operation is initiated if this bit is low.



The first byte after the START procedure.

4.3.2.7 Write data operation

The host device sends a command to module via write operation.

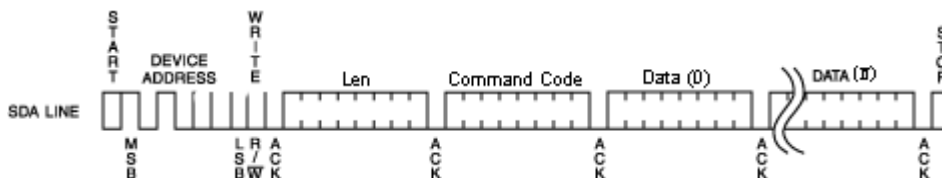

4.3.2.8 Read data operation

The host device gets result via read operation.

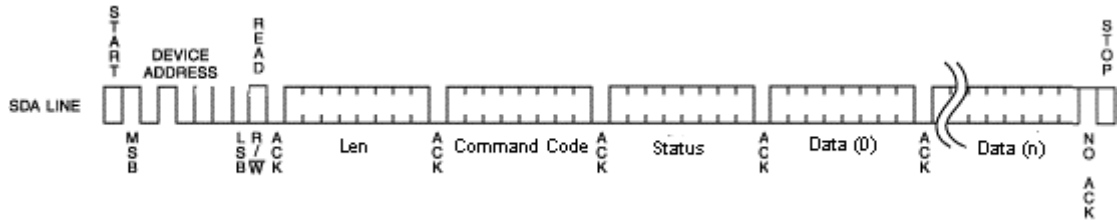

4.3.3 Data transaction

The module is a slave device of the IIC bus, then the host need to write the command package to module. The module will execute the command. Then the host needs to poll the status of the module while it is working by sending out the command of “read” continuously. If the module answered to a read operation, then the last command execution were finished. At this time the host could read the result and/or data from the module. The read and write operation see chapter 4.3.2.7 and 4.3.2.8.

4.3.4 Data send format

Length	Command	Data	Checksum
--------	---------	------	----------

- Length: 1 byte, number of bytes from Command length byte to the last byte of Data
- Command: 1 byte, the command of this instruction
- Data: length depends on the command type, length from 0 to 251 bytes
- Checksum: 1 byte, Exclusive OR (XOR) results from length byte to the last byte of data

4.3.5 Data return format

- Success:

Length	Command	Data	Checksum
--------	---------	------	----------

- Failure:

Length	Invert Command	Checksum
--------	----------------	----------

4.3.6 Description of IIC command transaction

E.g.: to read the block 1 of Mifare card, the steps:

Send command: 0A210001FFFFFFFFFFFF2A

There are steps here:

A. Write command to module

1. Start condition
2. Send control byte, it is 0xA0, the meaning is: address 0xA0 + write control 0x00
3. Send module command: 0x0A210001FFFFFFFFFFFF



4. Send command checksum: 0x2A
5. Stop condition
- B. Send IIC read command. If module no ACK, then the module is working. Repeat this step.
 1. Start condition
 2. Send control byte 0xA1, the meaning is address 0xA0 + read control 0x01
 3. If module is no ACK, go to step B. if yes, go to step C
- C. Get the data bytes from module
 1. Get the first byte and send ACK, if the data is 0x12, the meaning is there are 0x12 bytes useful bytes in this package.
 2. Get the else 17 bytes data(0x12-1=0x11) and send ACK after every byte
 3. Get the checksum and send NACK
 4. Stop condition
- D. Verify the checksum. if ok then the communication is ok
- E. Verify the received data from second byte; this byte is the status of the command just executed. If equal to the command (0x21) then the command execute successful. Then the following 16 bytes data which is the data that to be read in the card.



5 Description of commands

5.1 List of commands

Command code	Command function
0x10	Read product information
0x11	Module working mode set
0x12	Sets module idle
0x13	Set LED
0x14	Set buzzers
0x15	EEPROM read
0x16	EEPROM write
0x17	Set UART communication baud rate
0x19	Set IIC address
0x1A	Set multi-card operation
0x1C	Set automatic detecting card interval time
0x1D	Set the default automatic detect card state default
0x1E	Set automatic detect card and output card UID default
0x20	ISO14443A Request cards
0x21	Mifare 1K/4K data block read
0x2A	Mifare 1K/4K multi blocks read
0x22	Mifare 1K/4K data block write
0x2B	Mifare 1K/4K multi blocks write
0x23	Mifare 1K/4K purse block initialize
0x24	Mifare 1K/4K purse read
0x25	Mifare 1K/4K purse increment
0x26	Mifare 1K/4K purse decrement
0x27	Mifare 1K/4K purse copy
0x28	ISO14443A card halt
0x2D	Download Mifare 1K/4K card key to module
0x41	Ultra Light card read
0x42	Ultra Light card write
0x50	SAM slot default baud rate set
0x51	SAM reset
0x52	Set SAM baud rate after reset (through PPSS)
0x53	Send APDU to SAM



5.2 Explanation of commands

5.2.1 Read product information

Function: read the product information of CURRENT PRODUCT, includes product name, firmware version, firmware date and configuration information.

Host sends:

0x02	0x10	Checksum
------	------	----------

Module returns success:

0x1F	0x10	Information	Checksum
------	------	-------------	----------

Information: 29 bytes, 8 bytes product name(0x4A 4D 59 36 38 30 41 20), 4 bytes firmware version(0x35 2E 33 33), 8 bytes firmware date(0x32 30 31 32 30 35 32 39), 1 byte UART baud rate code(0x00), 1byte RFU(0x00), 1 byte IIC address(0xA0), 1 byte multi-card operation enable state(0x01), 2 bytes RFU, 1 byte automatic detecting card interval(0x14) (multiple of 10mS), 1byte default automatically detecting card status when power on(0x00), 1 byte default automatically output SNR set when power on(0x00)

Data in the brackets above taken from JMY680M default product information, as follow:

Send: 0x02 10 12

Return: 0x1F 10 4A 4D 59 36 38 30 41 20 35 2E 33 33 32 30 31 32 30 35 32 39 00 00 A0
01 00 00 14 00 00 AF

Module returns failure:

0x02	0xEF	Checksum
------	------	----------

5.2.2 Module working mode set

Function: set the antenna RF output ON/OFF; set the automatic detecting card ON/OFF.

Automatically detect card and output UID ON/OFF. The module will NOT SAVE the setting, and all settings will LOSE on next power on. The multi-card operation will be prohibited while users turn ON the automatic detecting card. If there is more than one card in the RF electric field then the operation will fail. Under the automatic detecting card and output UID state, after detected the card then output the UID via RS232, finally make the detected card



enter into idle state. This command cannot be used in IIC interface.

Host sends:

0x03	0x11	Mode	Checksum
------	------	------	----------

Mode: 1 byte

Antenna status: BIT0 = 0: OFF; BIT0 = 1: ON

Auto request: BIT1 = 0: OFF; BIT1 = 1: ON

Auto request and output UID: BIT2=0: OFF; BIT2=1: ON

Module returns success:

0x02	0x11	Checksum
------	------	----------

Module returns failure:

0x02	0xEE	Checksum
------	------	----------

5.2.3 Set module idle

Function: set the module idle. In idle mode, the module of RF output turn to OFF, PCD power down, and CPU in idle mode, so the power consumption reduces to about 100uA. Sending the next command to module will wake up the module, and then the RF output ON and automatic detecting card restore default settings. The module will enter into idle mode after the answer procedure is finished. In IIC mode, host need to read the answer and then the module will goes into idle mode.

Host sends:

0x03	0x12	Random data	Checksum
------	------	-------------	----------

Random data: 1 byte random data, for example: 0x55

Module returns success:

0x02	0x12	Checksum
------	------	----------

Module returns failure:

0x02	0xED	Checksum
------	------	----------

5.2.4 Set LED

Function: set the LED ON or OFF.

Host sends:



0x03	0x13	State	Checksum
------	------	-------	----------

State: 1 byte, 0: OFF, 1: ON, other value: RFU

Module returns success:

0x02	0x13	Checksum
------	------	----------

Module returns failure:

0x02	0xEC	Checksum
------	------	----------

5.2.5 Set buzzer

Function: set buzzer to beep.

Host sends:

0x03	0x14	Time	Checksum
------	------	------	----------

Time: 1 byte time, time unit is 10mS. If time is 0x0A, then the beep time is 100mS

Module returns success:

0x02	0x14	Checksum
------	------	----------

Module returns failure:

0x02	0xEC	Checksum
------	------	----------

5.2.6 EEPROM read

Function: read data in EEPROM of the module.

Host sends:

0x05	0x15	Address	Bytes	Checksum
------	------	---------	-------	----------

Address: 2 bytes, read start address, address from 0x0000 to 0x01FF, MSB first

Bytes: 1 byte, number of bytes to read, max. 64 bytes

Module returns success:

-	0x15	Data	Checksum
---	------	------	----------

Remark: the byte length is "-", means the byte length depends on the card feedback information. (The same to below)

Data: data read

Module returns failure:

0x02	0xEA	Checksum
------	------	----------



5.2.7 EEPROM write

Function: write data into EEPROM of the module

Host sends:

-	0x16	Address	Bytes	Data	Checksum
---	------	---------	-------	------	----------

Address: 2 bytes, write start address, address from 0x0000 to 0x01FF, MSB first

Bytes: 1 byte, number of bytes to read, max. 64 bytes

Data: "Bytes" data to write

Module returns success:

0x02	0x16	Checksum
------	------	----------

Module returns failure:

0x02	0xE9	Checksum
------	------	----------

5.2.8 Set UART communication baud rate

Function: set UART communication baud rate of the module. After module receive the command, it will first save the new setting, and then send the execute result according to the host. At last it will validate the new setting. UART communication baud rate is default 19200bps. Settings will SAVE in the module; it will not be lost after power OFF.

Host sends:

0x03	0x17	Baud rate	Checksum
------	------	-----------	----------

Baud rate: 1 byte, baud rate code; 0: 19200bps; 1: 115200bps; other values: RFU

Module returns success:

0x02	0x17	Checksum
------	------	----------

Module returns failure:

0x02	0xE8	Checksum
------	------	----------

5.2.9 Set IIC communication address

Function: set IIC communication address of the module. After module receive the command, it will first save the new address, and then send the executed result to the host. At last it will validate the new settings. The IIC address of the module is 1 byte HEX data. LSB is 0; the address of module must be the even number, and the invalid address will NOT be



accepted. Settings will save in the module, and it will be not lost after power OFF.

Host sends:

0x03	0x19	Address	Checksum
------	------	---------	----------

Address: 1 byte, LSB is 0; address must be the even number

Module returns success:

0x02	0x19	Checksum
------	------	----------

Module returns failure:

0x02	0xE6	Checksum
------	------	----------

5.2.10 Set multi-card operation

Function: set multi-card operation. If users need select on card from multi-card, then need to use the multi-card operation. If users set the automatic detecting card, the multi-card operation will be prohibited. If there is more than one card in the RF effective field then the operation will fail. Settings will save in the module; it will be not lost after power OFF. Multi-card operation default enables. This function is suitable for ISO14443A & ISO15693.

Host sends:

0x03	0x1A	Multi-card enable	Checksum
------	------	-------------------	----------

Multi-card enable: 1 byte, 0: disable multi-card; 1: enable multi-card; other values: RFU

Module returns success:

0x02	0x1A	Checksum
------	------	----------

Module returns failure:

0x02	0xE5	Checksum
------	------	----------

5.2.11 Set automatic detecting card interval time

Function: set interval time between two automatic detecting card

Host sends:

0x03	0x1C	Interval Time	Checksum
------	------	---------------	----------

Interval Time: 1 byte, 0x00 to 0xFF, unit is 10mS, 0x01 means 10mS.

Module returns success:

0x02	0x1C	Checksum
------	------	----------

Module returns failure:



0x02	0xE3	Checksum
------	------	----------

5.2.12 Set the default automatic detect card state default

Function: Set the default automatically detecting card state when boot device. For temporary open or close automatically detect card, please use the 0x11 command.

Host sends:

0x03	0x1D	State	Checksum
------	------	-------	----------

State: 1 byte, 0x00: OFF; 0x01: ON, other value: RFU

Module returns success:

0x02	0x1D	Checksum
------	------	----------

Module returns failure:

0x02	0xE2	Checksum
------	------	----------

5.2.13 Set automatic detect card and output card UID default

Function: Set automatically detecting card and output the card serial number when boot device. Under this model, the card serial number can be output from serial port when swiping the card. The RF protocol is following ISO14443A and ISO15693. The output format is the same to 0x20 and 0x5C command returned format. This command cannot be operated under IIC mode. When this command is on, then the read/write card cannot be operated because of the card entering into halt state once when the card is detected. If need to read/write card, automatically output the card serial number must be shut temporarily via 0x11 command and then go on with the read/write card operations.

Host sends:

0x03	0x1E	State	Checksum
------	------	-------	----------

State: 1 byte, 0x00: OFF; 0x01: ON, other value: RFU

Module returns success:

0x02	0x1E	Checksum
------	------	----------

Module returns failure:

0x02	0xE1	Checksum
------	------	----------



5.2.14 ISO14443A request cards

Function: ISO14443A request cards, cards include Mifare and other ISO14443A cards. In the return results, user can judge the length of serial number via the return data package length, and also judge the card type by ATQA, and judge whether the card supports ISO14443-4 by SAK. If automatic detecting card function was turned on, then this command is to take the result of automatic detecting card, not to detect card after received the command.

Host sends:

0x03	0x20	Mode	Checksum
------	------	------	----------

Mode: 1 byte, 0: WUPA (request all); 1: REQA (Request not halted only); other value: RFU

Module returns success:

-	0x20	Data	Checksum
---	------	------	----------

Data: 4, 7 or 10 bytes card serial number + 2 bytes ATQA + 1 byte SAK

Module returns failure:

0x02	0xDF	Checksum
------	------	----------

5.2.15 Mifare 1K/4K data block read

Function: read Mifare 1K/4K data block

Host sends:

0x0A	0x21	Key ID	Block	Key	Checksum
------	------	--------	-------	-----	----------

Key ID: 1 byte, Key identification

BIT0=0: Key A; BIT0 = 1: Key B;

BIT1=0: using the key in the command; BIT1 = 1: using the key downloaded by command 0x2D

BIT6:BIT5:BIT4:BIT3:BIT2: if use the downloaded key, this is the index of the key

BIT7=0: The block need to use the above key authentication

BIT7=1: The block has been certified and passed. This operation no need certification (the operation and automatically detect the card cannot be used at the same time)

(IMPORTANT: please read Chapter 5.3 about Key identification)



Block: 1 byte, Block number to read, 0 to 0x3F for S50; 0 to 0xFF for S70

Key: 6 bytes, the key of the card

Module returns success:

0x12	0x21	Data	Checksum
------	------	------	----------

Data: 16 bytes card data

Module returns failure:

0x02	0xDE	Checksum
------	------	----------

5.2.16 Mifare 1K/4K multi blocks read

Function: read multi data blocks in the same sector. The function is supported only in the same sector. If cross sectors, then read will fail.

Host sends:

0x0B	0x2A	Key ID	Start Block	Blocks	Key	Checksum
------	------	--------	-------------	--------	-----	----------

Key ID: 1 byte, key identification

Start Block: 1 byte, start block to read

Blocks: 1byte, number of block to read

Key: 6 bytes, the key of the card

Module returns success:

-	0x2A	Data	Checksum
---	------	------	----------

Data: (blocks)*(16 bytes card data)

Module returns failure:

0x02	0xD5	Checksum
------	------	----------

5.2.17 Mifare 1K/4K data block write

Function: write the data to a block of Mifare 1K/4K.

Host sends:

0x1A	0x22	Key ID	Block	Key	Data	Checksum
------	------	--------	-------	-----	------	----------

Key ID: 1 byte, Key identification

Block: 1 byte, Block number to write, 0 to 0x3F for S50; 0 to 0xFF for S70

Key: 6 bytes, the key of the card



Data: 16 bytes data to write

Module returns success:

0x02	0x22	Checksum
------	------	----------

Module returns failure:

0x02	0xDD	Checksum
------	------	----------

5.2.18 Mifare 1K/4K multi blocks write

Function: write multi blocks. The function is supported only in the same sector. If cross sector, it will fail while writing the first block and prompt the error in the returned result.

Host sends:

-	0x2B	Key ID	Start Block	Blocks	Key	Data	Checksum
---	------	--------	-------------	--------	-----	------	----------

Key ID: 1 byte, key identification

Start Block: 1 byte, the start block to write

Blocks: 1 byte, number of block to write

Key: 6 bytes, the key of the card

Data: (blocks)*(16 bytes data to write/block)

Module returns success:

0x02	0x2B	Checksum
------	------	----------

Module returns failure:

0x02	0xD4	Checksum
------	------	----------

5.2.19 Mifare 1K/4K purse block initialize

Function: initialize a block of Mifare 1K/4K to a purse. The format of purse uses Mifare 1K/4K's default. The key of the card could not use as a purse.

Host sends:

0x0E	0x23	Key ID	Block	Key	Value	Checksum
------	------	--------	-------	-----	-------	----------

Key ID: 1 byte, Key identification

Block: 1 byte, Block number to initialize, 0 to 0x3F for S50; 0 to 0xFF for S70

Key: 6 bytes, the key of the card

Value: 4 bytes, initialized value, LSB first

**Module returns success:**

0x02	0x23	Checksum
------	------	----------

Module returns failure:

0x02	0xDC	Checksum
------	------	----------

5.2.20 Mifare 1K/4K purse read

Function: read a purse of Mifare 1K/4K. The format of the purse uses Mifare 1K/4K's default. Module will read the data in the block and check if it is a purse format. If yes, return 4 bytes value data, if no, return failure.

Host sends:

0x0A	0x24	Key ID	Block	Key	Checksum
------	------	--------	-------	-----	----------

Key ID: 1 byte, Key identification

Block: 1 byte, block number of the value to read, 0 to 0x3F for S50; 0 to 0xFF for S70

Key: 6 bytes, the key of the card

Module returns success:

0x06	0x24	Data	Checksum
------	------	------	----------

Data: 4 bytes value data, LSB first

Module returns failure:

0x02	0xDB	Checksum
------	------	----------

5.2.21 Mifare 1K/4K purse increment

Function: purse increment of Mifare 1K/4K. The format of the purse uses Mifare1K/4K's default. Purse increment means the increment on the basis of the original number.

Host sends:

0x0E	0x25	Key ID	Block	Key	Value	Checksum
------	------	--------	-------	-----	-------	----------

Key ID: 1 byte, Key identification

Block: 1 byte, block number to initialize, 0 to 0x3F for S50; 0 to 0xFF for S70

Key: 6 bytes, the key of the card

Value: 4 bytes, increment value, LSB first

Module returns success:



0x02	0x25	Checksum
------	------	----------

Module returns failure:

0x02	0xDA	Checksum
------	------	----------

5.2.22 Mifare 1K/4K purse decrement

Function: purse decrement of Mifare 1K/4K. The format of the purse uses Mifare 1K/4K's default. Purse decrement means the decrement on the basis of the original number. Purse decrement only needs the read authority of the key.

Host sends:

0x0E	0x26	Key ID	Block	Key	Value	Checksum
------	------	--------	-------	-----	-------	----------

Key ID: 1 byte, Key identification

Block: 1 byte, Block number to initialize, 0 to 0x3F for S50; 0 to 0xFF for S70

Key: 6 bytes, the key of the card

Value: 4 bytes, decrement value, LSB first

Module returns success:

0x02	0x26	Checksum
------	------	----------

Module returns failure:

0x02	0xD9	Checksum
------	------	----------

5.2.23 Mifare 1K/4K purse copy

Function: copy the Mifare 1K/4K purse to another block in the same sector. The format of the purse uses Mifare 1K/4K's default.

Host sends:

0x0B	0x27	Key ID	Source	Target	Key	Checksum
------	------	--------	--------	--------	-----	----------

Key ID: 1 byte, Key identification

Source: 1 byte, block number to copy, 0 to 0x3F for S50; 0 to 0xFF for S70

Target: 1 byte, copy the purse to this block (source and target need in same sector)

Key: 6 bytes, the key of the card

Module returns success:

0x02	0x27	Checksum
------	------	----------

Module returns failure:



0x02	0xD8	Checksum
------	------	----------

5.2.24 ISO14443A card halt

Function: set the current operating ISO14443A card in halt state.

Host sends:

0x02	0x28	Checksum
------	------	----------

Module returns success:

0x02	0x28	Checksum
------	------	----------

Module returns failure:

0x02	0xD7	Checksum
------	------	----------

5.2.25 Download Mifare 1K/4K card key to module

Function: download the Mifare 1K/4K card key to module. There are 32 key memory spaces in the module that can storage 32 different keys. When using the downloaded key on the module, this key wouldn't appear on the pin-outs of the PCD. So it could provide more security.

Host sends:

0x09	0x2D	Key Index	Key	Checksum
------	------	-----------	-----	----------

Key Index: 1 byte, store the Key Index in the module, Index values from 0 to 0x1F

Key: 6 bytes, the key of the card to store in module

Module returns success:

0x02	0x2D	Checksum
------	------	----------

Module returns failure:

0x02	0xD2	Checksum
------	------	----------

5.2.26 Ultra Light card read

Function: read the data from Ultra Light card. A read command will read 4 blocks data from the card. If read start block is the last block (0x0F), then these 4 blocks data are the 15th, 0th, 1st and 2nd block.

Host sends:



0x03	0x41	Read start block	Checksum
------	------	------------------	----------

Read start block: 1 byte, start block number to read

Module returns success:

0x12	0x41	Data	Checksum
------	------	------	----------

Data: 16 bytes card data of 4 blocks, a read operation read 4 blocks from the start block.

Module returns failure:

0x02	0xBE	Checksum
------	------	----------

5.2.27 Ultra Light card write

Function: write data to Ultra Light card. Each for one block data.

Host sends:

0x07	0x42	Block	Data	Checksum
------	------	-------	------	----------

Block: 1 byte, block number to write

Data: 4 bytes data to write

Module returns success:

0x02	0x42	Checksum
------	------	----------

Module returns failure:

0x02	0xBD	Checksum
------	------	----------

5.2.28 SAM slot default baud rate set

Function: Before SAM card reset, to set default baud rate of the SAM slot. This baud rate will be used by the reader to reset the SAM. In ISO7816, the default baud rate for the card is 9600bps.

Host sends:

0x03	0x50	Baud rate	Checksum
------	------	-----------	----------

Baud rate: 1 byte, baud rate code of SAM, 0: 9600bps (default); 2: 38400bps; other value: RFU

Module returns success:

0x02	0x50	Checksum
------	------	----------

Module returns failure:

0x02	0xAF	Checksum
------	------	----------



5.2.29 SAM reset

Function: reset the SAM in the slot, get ATQ and set the relevant communication parameter.

Host sends:

0x02	0x51	Checksum
------	------	----------

Module returns success:

-	0x51	ATQ	Checksum
---	------	-----	----------

ATQ: Answer To Reset of the SAM, the length is depend on the card

Module returns failure:

0x02	0xAE	Checksum
------	------	----------

5.2.30 Set SAM baud rate after reset (through PPSS)

Function: some SAM support PPSS instruction and then user could modify the communication baud rate.

Host sends:

0x03	0x52	Baud rate	Checksum
------	------	-----------	----------

Baud rate: 1 byte, baud rate code of SAM, 0: 9600bps; 2: 38400bps; other value: RFU

Module returns success:

0x02	0x52	Checksum
------	------	----------

Module returns failure:

0x02	0xAD	Checksum
------	------	----------

5.2.31 Send APDU to SAM

Function: send APDU (COS command) to SAM and get result.

Host sends:

-	0x53	APDU	Checksum
---	------	------	----------

APDU: APDU need to send

Module returns success:

-	0x53	Response	Checksum
---	------	----------	----------

Response: response of SAM, the length is depend on the detailed command

Module returns failure:



0x02	0xAC	Checksum
------	------	----------



5.3 About KEY Identification

There is a byte of KEY identification in command of Mifare 1K/4K read/write. This byte will identify the way to get the card key

Key Identification							
BIT7	BIT6	BIT5	BIT4	BIT3	BIT2	BIT1	BIT0

BIT0=0: KEY A; authenticate Key A of the card.

BIT0=1: KEY B; authenticate Key B of the card.

BIT1=0: Using the following 6bytes Key in command.

BIT1=1: Using the downloaded Key by command.

BIT6: BIT5: BIT4: BIT3: BIT2: Index of the Key already downloaded (0 to 31).

BIT7=0: The block need to be certified via the above key

BIT7=1: The block has been authenticated. Current operation does not need authentication (this operation and automatically detect card cannot be used at the same time)

If BIT1 is 0, then these 5 bits (BIT6 to BIT2) are unused. If BIT1 is 1, then use the already downloaded key. Users need to download key(s) by using command first; and then the 6 bytes key in the command are left unused, but the 6-byte is necessary in the command sequence.

E.g.: key Identification is 0x00; binary system is 00000000, here:

BIT0 = 0; authenticate Key A of the card

BIT1 = 0; using the key in command

BIT6:BIT5:BIT4:BIT3:BIT2: 00000, because not use the already downloaded key, the index key is unused in this command.

E.g.: key Identification is 0x33; binary system is 00110011, here:

BIT0 = 1; authenticate Key B of the card

BIT1 = 1; using the downloaded Key in the module

BIT6:BIT5:BIT4:BIT3:BIT2:01100, then use the already downloaded key 01100, and hexadecimal is 0x0C, decimal is 12.

5.4 About the automatic detecting card

The automatic detecting card function support Mifare class. The default state could be set via 0x1D command. This setting will affect on the next power up. After power up, the automatic detect card function can be temporary ON or OFF via 0x11 commands. The module after re-power will return to the default state.

Automatic detecting card supports full function of Mifare 1K/4K and Ultra Light.

Automatic detecting card supports single card operation only. If there is more than one card in the RF effective field then the operation may fail. Then the multi-card operation will automatically turn OFF while the automatic detect card function is ON.



5.5 Example of commands

5.5.1 About UART communication protocol

For example:

Read block 1: 0A210001AABBCCDDEEFF3B

0A: package length; from 0A to FF are total 0x0A bytes

21: instruction of read

00: Authenticate KEY A, using the key in package. The key is "AABBCCDDEEFF"

01: block number to read

AABBCCDDEEFF: key of the sector of the card

3B: $0A \wedge 21 \wedge 00 \wedge 01 \wedge AA \wedge BB \wedge CC \wedge DD \wedge EE \wedge FF = 3B$, in sample program, the function will calculate it.

5.5.2 UART commands sample

Read block 1	0A210001FFFFFFFFFFFF2A
Read block 255 (S70)	0A2100FFFFFFFFFFFFFD4
Write block 1	1A220001FFFFFFFFFFFF1234567890ABCDEF1234567890ABCDEF39
Request card (WUPA)	AABB 03200023
Halt card	AABB 021210

5.5.3 IIC commands sample

Read block 1	0A210001FFFFFFFFFFFF2A
Read block 255 (S70)	0A2100FFFFFFFFFFFFFD4
Write block 1	1A220001FFFFFFFFFFFF1234567890ABCDEF1234567890ABCDEF39
Request card (WUPA)	03200023
Halt card	021210

5.6 Interface program source code

We have interface program source code to help users. They are KELL project in C51 or ASM51 format. Please mail to jinmuyu@vip.sina.com to obtain the program.